

MIQ/Blue PS Set

SET FOR WIRELESS DATA TRANSMISSION IN THE IQ SENSOR NET



a xylem brand

CE conformity

WTW herewith declares that the MIQ/Blue PS instrument is in compliance with the basic requirements and other relevant regulations of the directive 1999/5/EC.

The EC conformity declaration is available on request from WTW.

Copyright

© Weilheim 2013, WTW GmbH

Reprinting - even as excerpts - is only allowed with the explicit written authorization of WTW GmbH, Weilheim.

Printed in Germany.

MIQ/Blue PS - Contents

1	Overview	1-1
1.1	How to use this component operating manual	1-1
1.2	Features of the MIQ/Blue PS	1-2
1.2.1	General characteristics	1-2
1.2.2	Instrument identification	1-3
1.2.3	Application examples	1-4
2	Safety instructions	2-1
2.1	Authorized use	2-2
2.2	General safety instructions	2-2
3	Installation	3-1
3.1	Scope of delivery	3-1
3.2	Basic information on installation	3-1
3.2.1	General information	3-1
3.2.2	Power supply	3-2
3.2.3	Topology and terminator switch	3-3
3.3	Radio range	3-8
3.4	Installation in the IQ SENSORNET	3-13
3.5	Electrical connections: General instructions	3-14
3.6	Connecting the voltage supply	3-16
3.6.1	Connection to 100 ... 240 V AC	3-16
3.6.2	Connection to 24 V DC	3-20
3.7	Figure of the terminal strip	3-23
4	Maintenance and cleaning	4-1
4.1	Maintenance	4-1
4.2	Cleaning	4-1
5	What to do if ...	5-1
5.1	Check of the radio connection	5-1
5.2	Error causes and remedies	5-2
6	Technical data	6-1
6.1	Electrical data	6-1
6.1.1	Operation without line power supply unit	6-1
6.1.2	Operation with line power supply unit	6-1
6.1.3	Electrical connections	6-3

6.2	Radio transmission	6-3
6.3	Instrument safety	6-3
7	Appendix: Installation instructions for several radio links	7-1
7.1	General information	7-1
7.2	Application example for several radio links	7-1
7.3	Power supply	7-2
8	Contact Information	8-3
8.1	Ordering & Technical Support	8-3
8.2	Service Information	8-3

1 Overview

1.1 How to use this component operating manual

Structure of the IQ SENSORNET operating manual

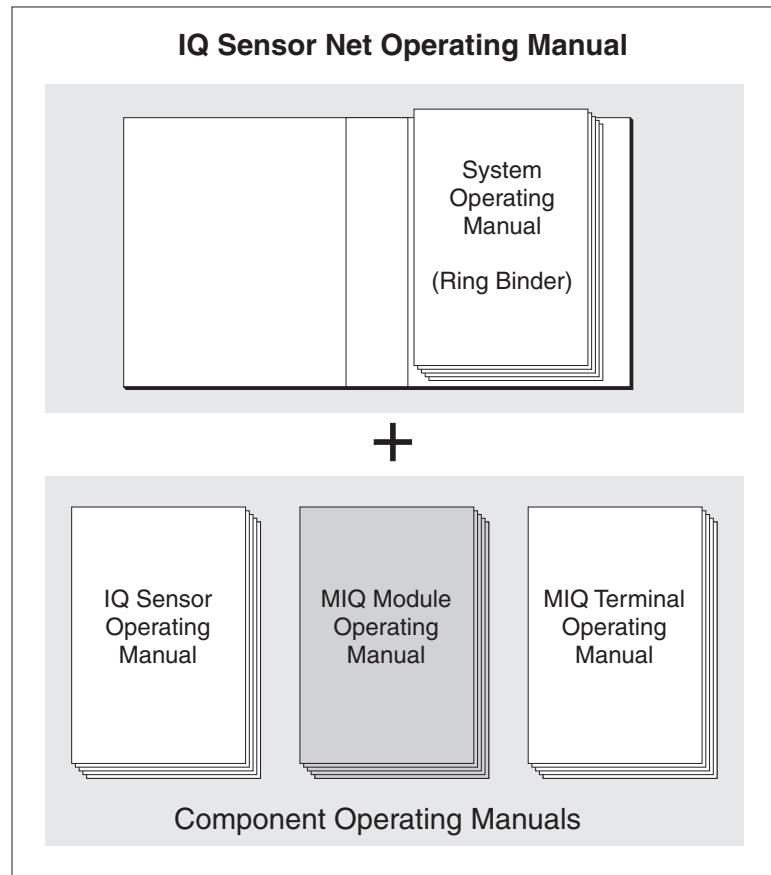

Fig. 1-1 Structure of the IQ SENSORNET operating manual.

The IQ SENSORNET operating manual has a modular structure like the IQ SENSORNET system itself. It consists of a system operating manual and the operating manuals of all the components used.

Please file this component operating manual into the ring binder of the system operating manual.

1.2 Features of the MIQ/Blue PS

1.2.1 General characteristics

With the aid of the MIQ/Blue PS SET you can replace an IQ SENSORNET line section by a radio link. When doing so a new IQ SENSORNET island is formed (Fig. 1-2):

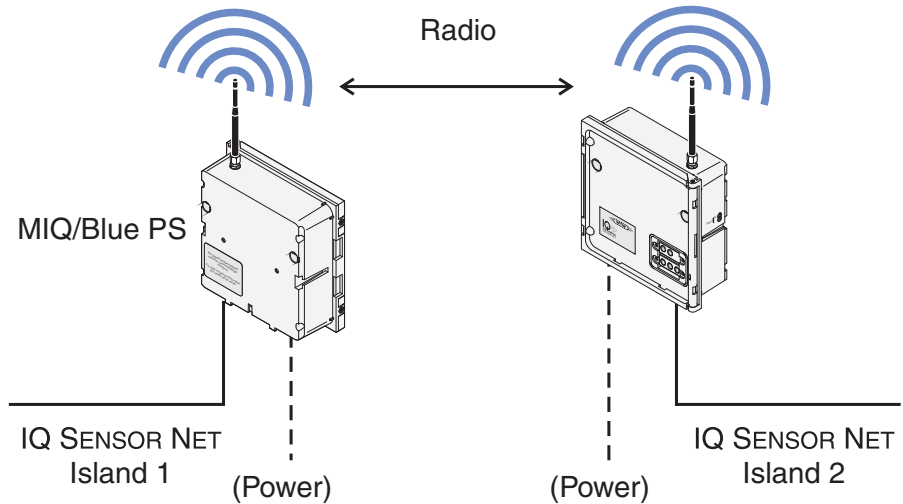

Fig. 1-2 Structure of a radio link with the MIQ/Blue PS SET

Radio technology using Bluetooth modules features reliability and insensitivity to foreign electromagnetic radiation. Transmission between two MIQ/Blue PS modules of a set takes place in an encoded form. In conjunction with the proprietary IQ SENSORNET record, the transmission is thus tap-proof.

The antennas of the MIQ/Blue PS modules are omni-antennas without directivity.

Power supply

To supply an IQ SENSORNET island with power, a line power supply unit is integrated in the MIQ/Blue PS. I can supply components with a total power consumption of up to 7 watt, which is sufficient for most applications. The line power supply unit of the MIQ/Blue PS can be supplied with line power or with 24 V. Thus, an island can also be supplied by a battery or solar system.

Terminal strip

The MIQ/Blue PS has the following electrical connections on the terminal strip inside the enclosure:

- 1 x line power connection 100 ... 240 VAC, two-pole
- 1 x line power connection 24 VDC, two-pole
- 3 x SENSORNET connections

1.2.2 Instrument identification

The nameplate is on the side of the module enclosure. Among other, it contains the following information (Fig. 1-3):

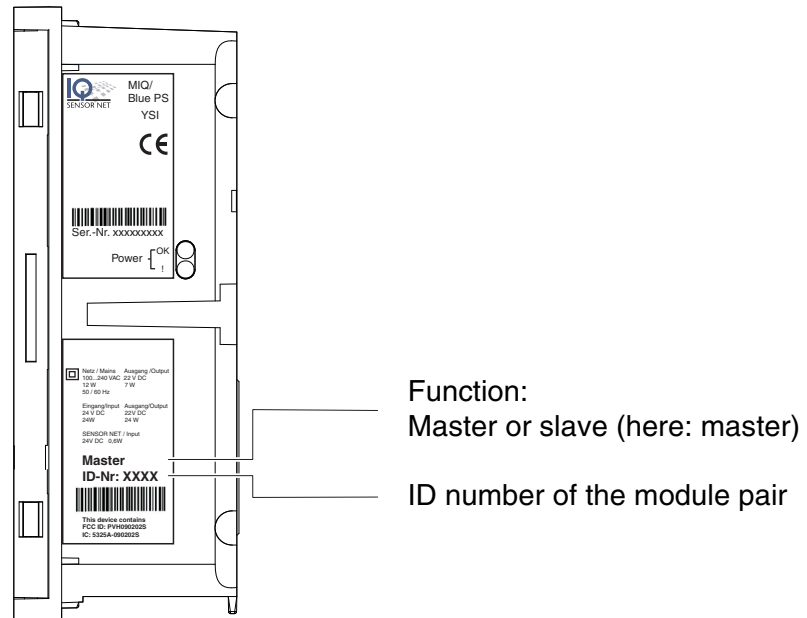

Fig. 1-3 Nameplate of the MIQ/Blue PS

ID number and encoding

An MIQ/Blue PS SET consists of a module pair with the same ID number. Every module pair has its own coding of the radio transmission, which is determined via the ID number. Any ID number is assigned only once by YSI. This excludes the possibility of several module pairs having the same encoding and thus, of interferences by a module pair that happens to have the same encoding. With several MIQ/Blue PS pairs, the ID number enables to identify which pair communicates with each other.

1.2.3 Application examples

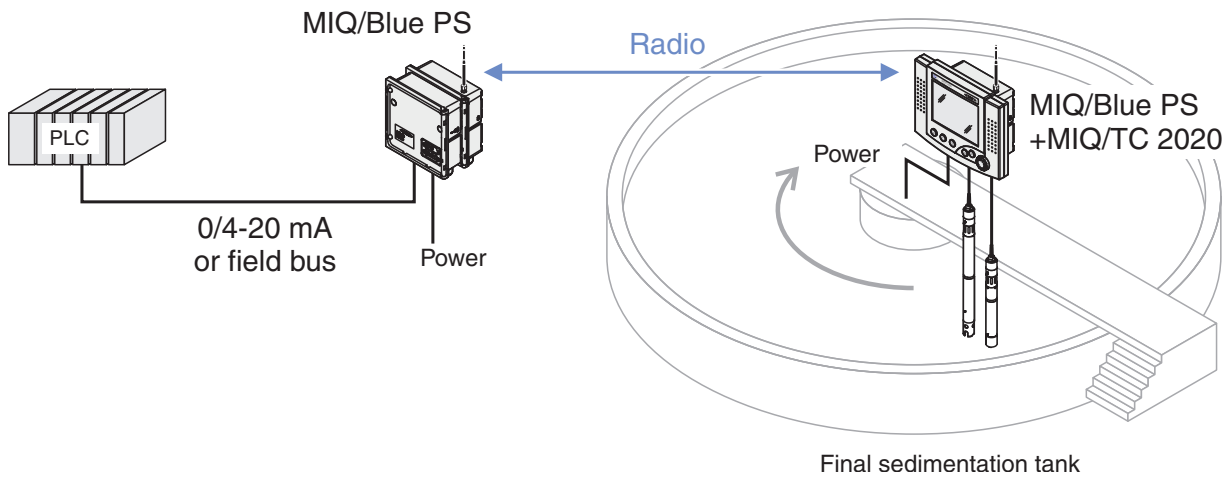

Fig. 1-4 Example 1: Basin with rotating scraper bridge

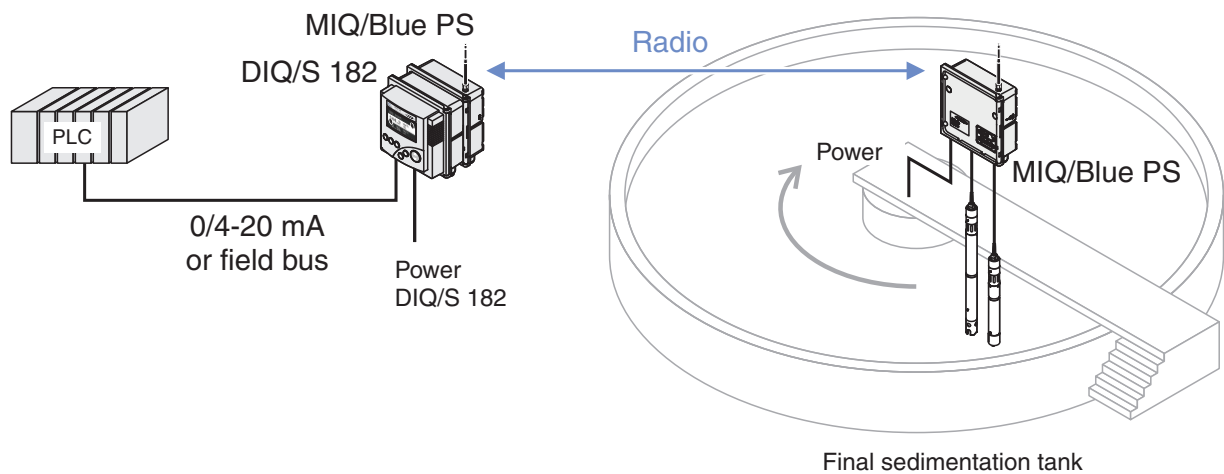

Fig. 1-5 Example 2: Basin with rotating scraper bridge

2 Safety instructions

This component operating manual contains special instructions that must be followed during the installation of the MIQ/Blue PS power supply module. Thus, it is essential to read this component operating manual before carrying out any work using this component. In addition to this manual, the SAFETY chapter of the IQ SENSORNET system operating manual must be followed.

Always keep this component operating manual together with the system operating manual and all other component operating manuals in the vicinity of the IQ SENSORNET system.

Special user qualifications

The MIQ/Blue PS may only be connected to the line power supply by a trained electrician.

General safety instructions

Safety instructions in this operating manual are indicated by the warning symbol (triangle) in the left column. The signal word (e.g. "CAUTION") indicates the danger level:



Warning

indicates instructions that must be followed precisely in order to prevent serious dangers to personnel.



Caution

indicates instructions that must be followed precisely in order to avoid slight injuries to personnel or damage to the instrument or the environment.

Other labels



Note

indicates notes that draw your attention to special features.



Note

indicates cross-references to other documents, e.g. operating manuals.

2.1 Authorized use

Authorized use of the MIQ/Blue PS is its use as a radio module with optional line power supply unit in the IQ SENSORNET. Please observe the technical specifications according to chapter 6 TECHNICAL DATA. Only operation according to the instructions in this operating manual is authorized.

Any other use is considered to be **unauthorized**. Unauthorized use invalidates any claims with regard to the guarantee.

2.2 General safety instructions

The MIQ/Blue PS is constructed and inspected according to the relevant guidelines and norms for electronic instruments (see chapter 6 TECHNICAL DATA).

It left the factory in a safe and secure technical condition.

Function and operational safety

The failure-free function and operational safety of the MIQ/Blue PS is only guaranteed if the generally applicable safety measures and the special safety instructions in this operating manual are followed during its use.

The failure-free function and operational safety of the MIQ/Blue PS is only guaranteed under the environmental conditions that are specified in chapter 6 TECHNICAL DATA.

Safe operation

If safe operation is no longer possible, the MIQ/Blue PS must be taken out of operation and secured against inadvertent operation.

Safe operation is no longer possible if the MIQ/Blue PS:

- has been damaged in transport
- has been stored under adverse conditions for a lengthy period of time
- is visibly damaged
- no longer operates as described in this manual.

If you are in any doubt, contact the supplier of your MIQ/Blue PS.

3 Installation

3.1 Scope of delivery

The scope of delivery of the MIQ/Blue PS module includes:

- MIQ/Blue PS
- Accessory set, including
 - 4 x cable glands (clamping range 4.5-10 mm) with seals and blind plugs
 - 4x ISO blind nuts M4 with suitable socket head screws and plain washers
 - 2x countersunk screws M3x8 to close the module lid (+ 2 spare ones)
 - 1 x contact base with fixing screws
- Accessories for range test with attenuator (see section 3.3)
 - 1 x SMA attenuator VAT 10 dB
 - 2 x reverse SMA adapters for SMA attenuator
- Operating manual.

3.2 Basic information on installation

3.2.1 General information

The MIQ/Blue PS radio modules are preconfigured in pairs and ready for installation. Installation consists only of the connection to the IQ SENSORNET.



Note

This chapter describes the installation of one radio link in the IQ SENSORNET system. If several radio links should be installed, the instructions in the appendix of this operating manual have to be followed additionally.



Note

To prevent the radio transmission from being affected by water or snow collecting on the antenna, we urgently recommend protecting any MIQ/Blue PS radio modules against precipitation with the aid of a plastic canopy (SSH/IQ).

3.2.2 Power supply

The line power supply unit of the MIQ/Blue PS can be used for the exclusive supply of an IQ SENSORNET island. In any case, a separate power rating has to be made for each IQ SENSORNET island.

Power delivery	24 V DC operation:	24 W
	100 ... 240 V AC operation:	7 W

Compatibility with other line power supply units

If the installation of further line power supply units should be necessary, please note the following: If other power supply modules (e.g. MIQ/PS) are installed on the IQ SENSORNET island, the line power supply unit of the MIQ/Blue PS is automatically inactive. Connecting the MIQ/Blue PS line power supply unit to a power supply remains ineffective here. In this case, the MIQ/Blue PS is a consumer with a power consumption of 0.6 W in the power rating.

Example

Problem:

- An IQ SENSORNET island should consist of the following components plus the MIQ/Blue PS:

Component	Power requirement [W]
VisoTurb [®] 700 IQ	1.5
ViSolid [®] 700 IQ	1.5
SensoLyt [®] 700 IQ	0.2
MIQ/CHV PLUS	1.0
MIQ/TC 2020 XT (docked from time to time)	3.0

- In this example, the MIQ/Blue PS and the MIQ/CHV PLUS should be mounted as a stack.
- The IQ SENSORNET system should be supplied with 100 ... 240 V AC.

Solution/proceeding:

- First it is assumed that the MIQ/Blue PS suffices for power supply. It does not have to be taken into account as a consumer. In the worst case, i. e. with a docked MIQ/TC 2020 XT, the power requirement of all components is 7.2 W. Power losses in cables do not have to be taken into account due to the stack mounting.
- Power rating: The calculated power requirement is greater than the maximum power delivery of the MIQ/Blue PS line power supply unit. Therefore, an additional power supply module has to be installed (e.g. MIQ/PS).
- New power rating: The MIQ/Blue PS has to be counted as a consumer as well. Therefore, the power consumption is now 7.8 W.

With an MIQ/PS power supply module (18 W), there is still an energy reserve of 10.2 W for any future extensions.

3.2.3 Topology and terminator switch

For failure-free operation, the terminator switches (terminating resistors) must always be set to ON on two MIQ modules of the IQ SENSORNET island. On which modules this is required results from the topology of the IQ SENSORNET island:

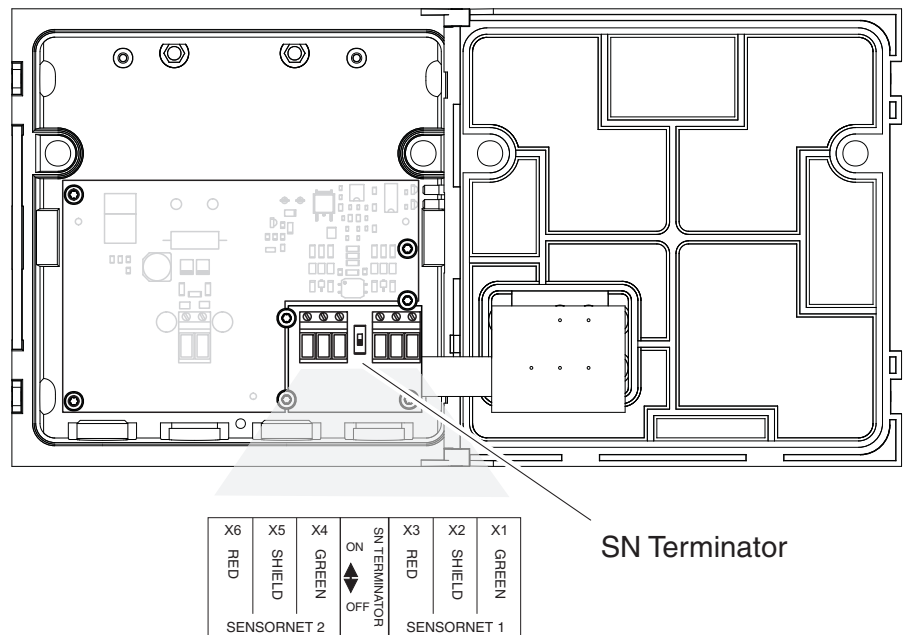

Fig. 3-1 Correct setting of the terminator switches

- Main line (trunk line)** Longest cable section with terminator switches at its ends.
 The terminator switches must be set to On at both ends.
 If all MIQ modules are located at one point, i. e. in a module stack, the length of the main line is zero (star-shaped wiring).
- Branch line** All lines branching from the main line.
 Branch lines can be branched further.

Special features with certain configurations

- If, except in the MIQ/Blue PS, no other terminator switch is available on the IQ SENSORNET island, it must be set to ON. In addition, a terminating resistor (included in the scope of delivery) must be connected to one of the three SENSORNET connectors. For more details, see page 3-6.
- If a DIQ/S 182 Universal Transmitter is on the IQ SENSORNET island, all terminator switches on the IQ SENSORNET island must be set to ON.

Example of determining the main line

The following figure shows the main line L made up of the partial lengths L1, L2 and L3 as the cable section L4 is shorter than L3:

$$\text{Length of the main line} = L1 + L2 + L3$$

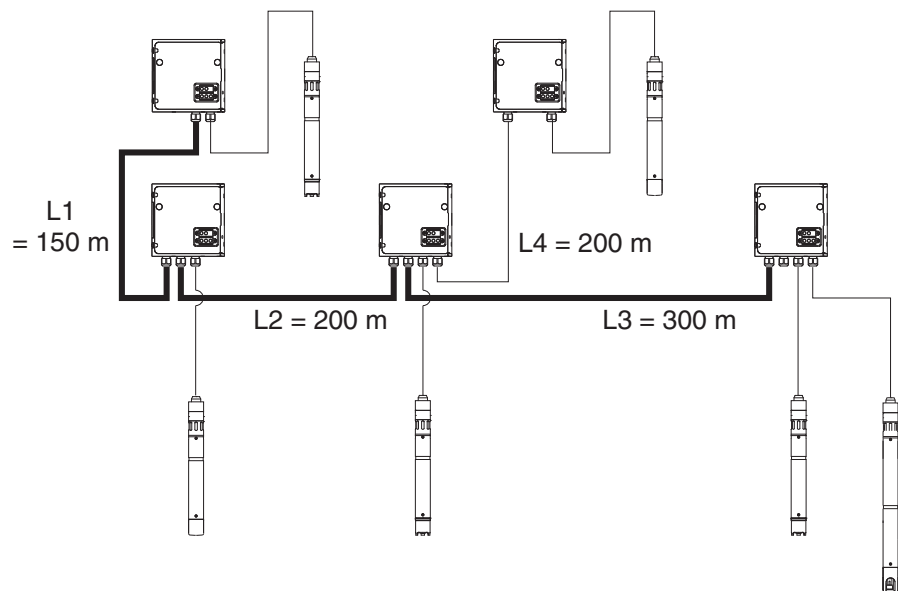

Fig. 3-2 Example of determining the length of the main line

Terminator switch

Terminator switches are located in each MIQ module between the two SENSORNET connections on the right of the terminal strip (designation "SN TERMINATOR").

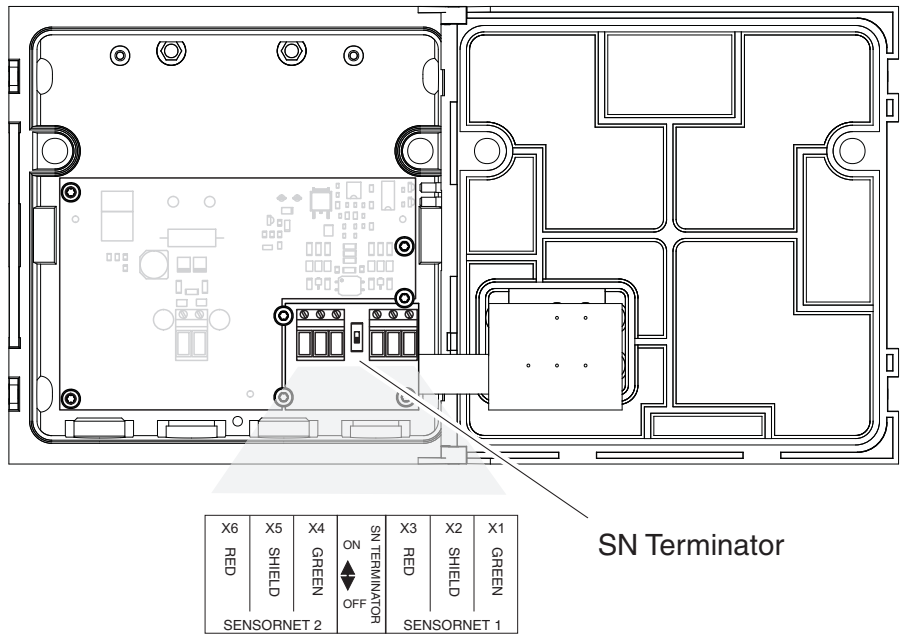

Fig. 3-3 Terminator switch

Additional terminating resistor on the MIQ/Blue PS

An additional terminating resistor is only required if, except in the MIQ/Blue PS, no other terminator switch is available on the IQ SENSORNET island. The terminating resistor is connected to one of the three SENSORNET connectors (Fig. 3-4). The terminating resistor must bridge the two outside terminals of the SENSORNET connector. The SENSORNET connector can still be used to connect a sensor.

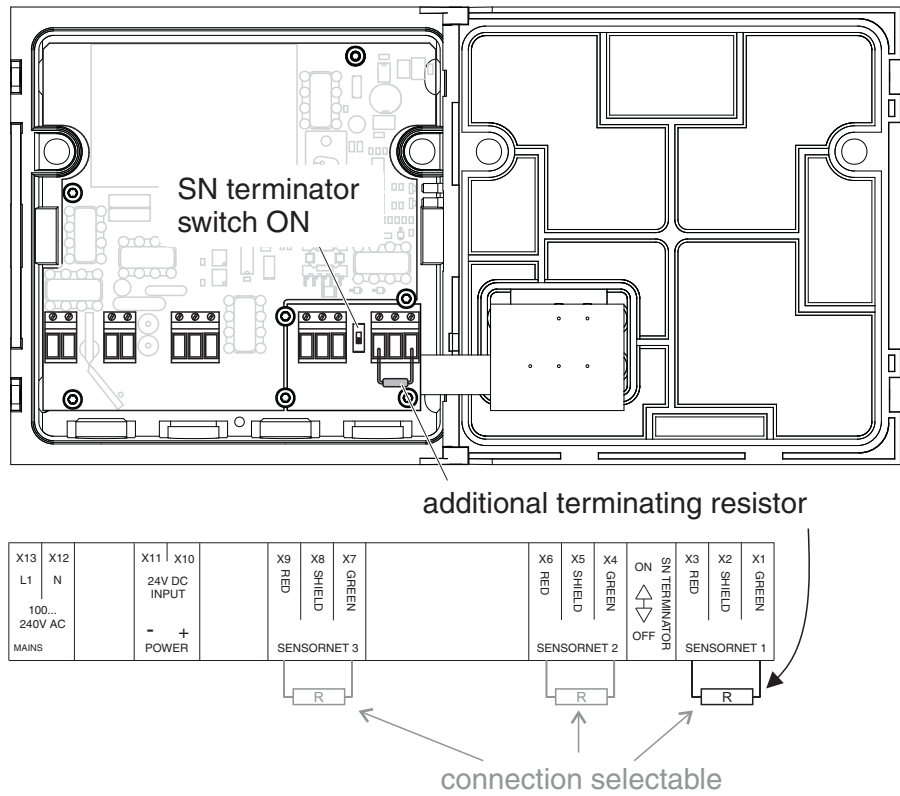

Fig. 3-4 MIQ/Blue PS with additional terminating resistor

Examples of the correct setting of the terminator switches

The figure on the following page demonstrates with several examples of IQ SENSORNET islands how the terminator switches and terminating resistors are correctly set.

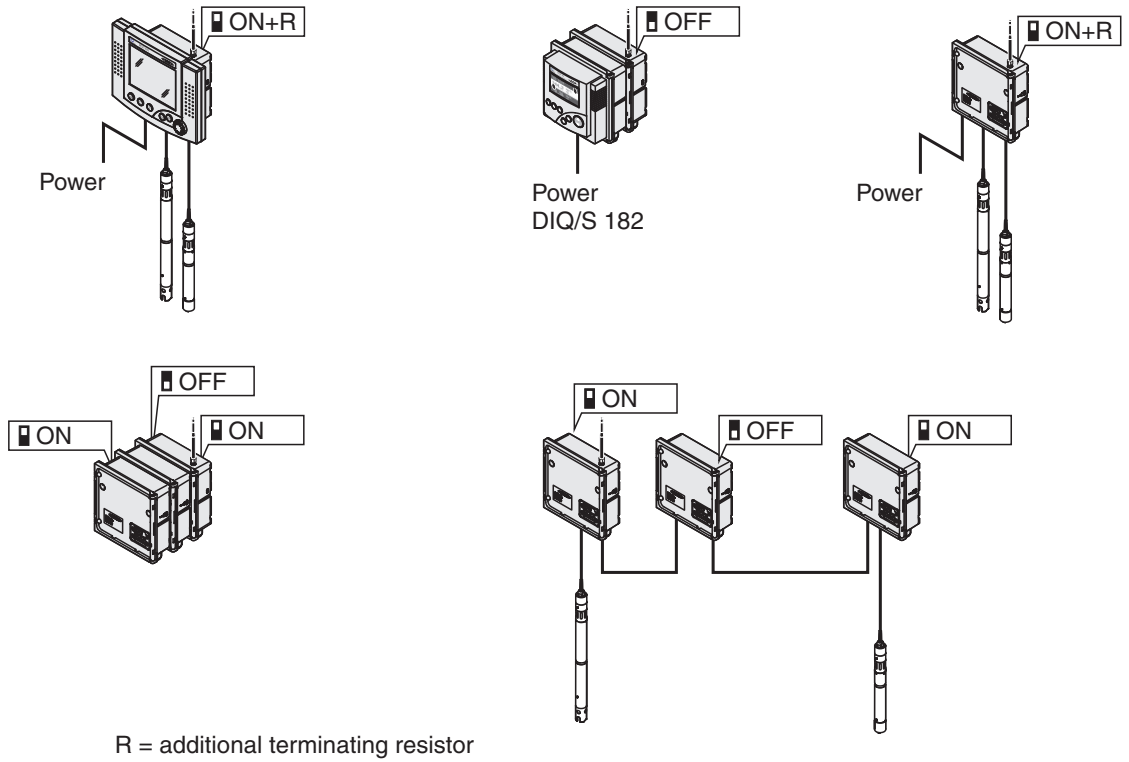

Fig. 3-5 Terminator switches and terminating resistors

3.3 Radio range

The range of a radio link with MIQ/Blue PS SET in the free field is up to 100 m with installation and testing according to this chapter (see chapter 6 TECHNICAL DATA).

As with any other radio technology, the following points have to be observed when installing the MIQ/Blue PS SET:

- All materials (even window glass) in the radio link reduce the range. Therefore, keep the radio link free of barriers (even temporary ones). Both MIQ/Blue PS modules should be in permanent "visual contact" through the air. Take into account that there may be short-time events such as trucks driving by that interrupt the radio link.
- Water, snow and ice on the antenna will reduce the range. When it is installed in the free field, protect the MIQ/Blue PS against water, snow and ice. Use the plastic canopy SSH/IQ for this. Canopies made out of metal or PVC reduce the range!
- A high location of the MIQ/Blue PS increases the range. If necessary, install the MIQ/Blue PS higher over ground.

MIQ/Blue PS

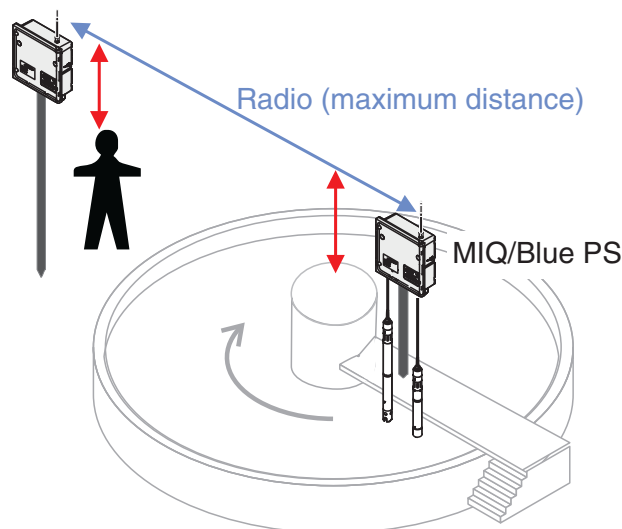

Fig. 3-6 Height of the location for the MIQ/Blue PS module

- Install the MIQ/Blue PS where the mentioned requirements are best available and establish the connection to the IQ SENSORNET island with the aid of the SNCIQ cable. Do not in any case use an antenna extension cable to improve the position of the antenna alone. Antenna extension cables cause range losses.
- Mount the MIQ/Blue PS outside of a building on a pole and run the SNCIQ cable through the wall to the next MIQ module.

**Example: IQ SENSORNET
island in a building.**

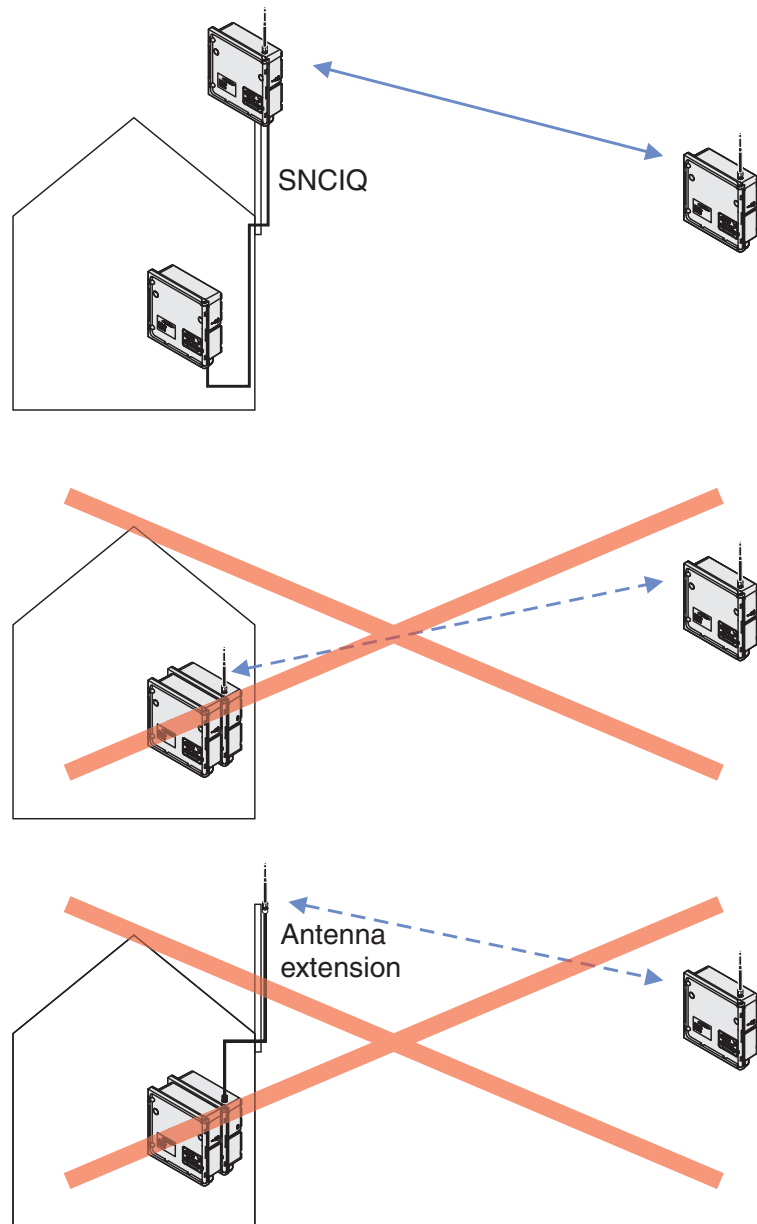

Fig. 3-7 Installation of the MIQ/Blue PS



Note

When installing several radio links:

Follow the "Master" or "Slave" labeling of the individual MIQ/Blue PS modules. The labeling of a MIQ/Blue PS module is on the name plate (see section 1.2.2):

- Mount every MIQ/Blue PS master with a maximum distance to the next master (at least 50 m).
- Mount every MIQ/Blue PS slave with a minimum distance of 2 m to the next slave.

Maximum distance of the MIQ/Blue PS masters (examples)

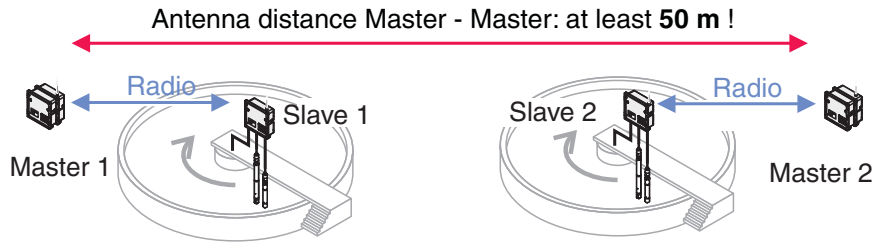

Fig. 3-8 Example 1: Maximum distance of the MIQ/Blue PS masters

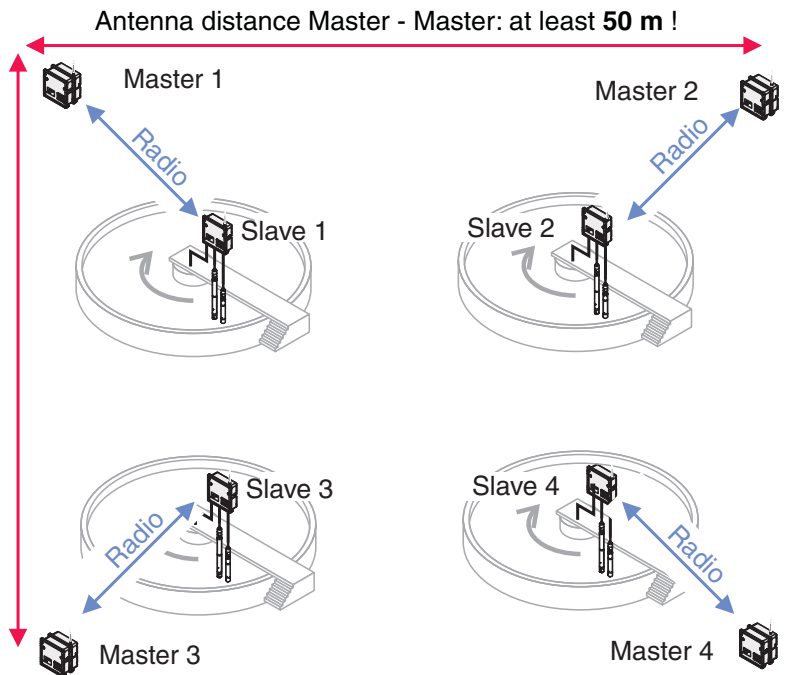

Fig. 3-9 Example 2: Maximum distance of the MIQ/Blue PS masters

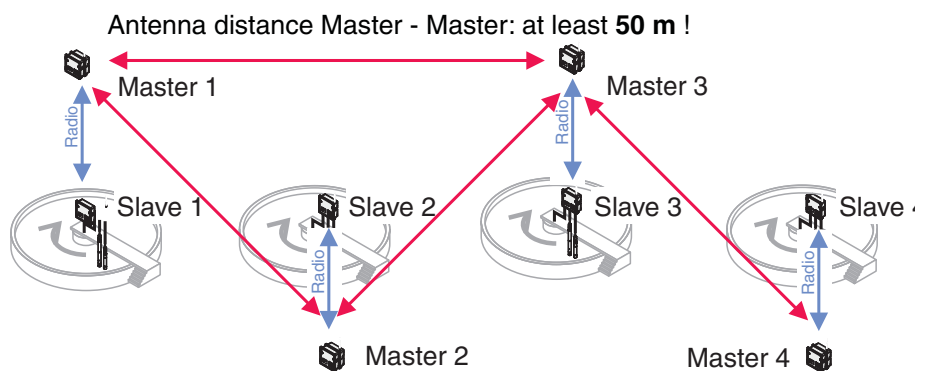

Fig. 3-10 Example 3: Maximum distance of the MIQ/Blue PS masters

**Note**

If it is not possible to keep the minimum distances of the MIQ/Blue PS masters, you can reduce interferences of the radio communication by shielding the modules against one another (e.g. by using directional antennas with side-lobe suppression in conjunction with attenuators). If necessary, contact a radio technology specialist.

**Note**

If high gain antennas in order to increase the range are used, the requirements of the directive 1995/5/EC will not be met.

Range test with attenuator

To test the quality of the radio link, carry out the following test with a defined signal attenuation:

**Note**

If a canopy is used, the MIQ/Blue PS has to be mounted lower on the canopy for the duration of the range test. If necessary, use the lower boreholes in the plastic canopy (SSH/IQ) for this.

1	Unscrew the antenna from on of the two MIQ/Blue PS modules. For the test, insert the attenuator with both adapters between the antenna connector of the module enclosure and the antenna.
2	Test the radio link with the attenuator under the most unfavorable conditions such as with installation on rotating scraper bridges and the utmost distance of both MIQ/Blue PS modules. If the test is successful with signal attenuation, faultless operation should also be possible under unfavorable conditions (e.g. fog, heavy rainfall, snow).
3	To terminate the test operation, remove the attenuator and mount the antenna directly on the MIQ/Blue PS again.
4	If you had mounted the MIQ/Blue PS lower on the canopy for the test: Mount the MIQ/Blue PS higher on the canopy again.

Radio link check list

For safe operation of a radio link, check the system with the following check list.

The following checklist supports you when planning, projecting and installing a radio link with the MIQ/Blue PS radio modules.

For smooth operation, you should be able to answer all questions with "Yes".

Radio link check list:

- 1 Is there direct visual contact between the antennas of both MIQ/Blue PS modules at any time (e.g. with installation on moving scraper bridges)?
- 2 Is the radio link free from permanent disturbances? Examples:
 - Obstacles (such as buildings, windows, etc.)
 - Shielding (such as a metal or PVC canopy)
- 3 Is the radio link free from temporary disturbances? Examples:
 - Regular temporary disturbances (e.g. center support or mounting stand, with installation on a moving scraper bridge)
 - Irregular temporary disturbances (e.g. vehicles or persons crossing the radio link)
- 4 Are the antennas of the MIQ/Blue PS modules free of water, snow, ice?
- 5 When using a canopy:
Is the SSH/IQ plastic canopy used (no metal or PVC canopy)?
- 6 Are the antennas in the original condition (e.g. no antenna extension cable)?
- 7 Was the range test carried out with attenuator?
- 8 With installation on a moving scraper bridge:
Was the range test carried out for a complete rotation of the scraper bridge?
- 9 Is the distance between 2 MIQ/Blue PS masters (for several radio links) at least 50 m?
- 10 Is the distance between 2 MIQ/Blue PS slaves (for several radio links) at least 2 m?

**Note**

Interferences are possible also with short radio links if the radio signal is reflected by walls that are outside the direct radio link. Due to reflections, radio signals may reach the receiver alleviated or several times. In this case, changing the location of a MIQ/Blue PS module only slightly can improve the transmission.

3.4 Installation in the IQ SENSORNET

The IQ SENSORNET provides a number of options for integrating the MIQ/Blue PS mechanically and electrically in the system (stacked mounting, distributed mounting, etc.). The individual types of installation are described in detail in the INSTALLATION chapter of the system operating manual.

**Note**

If there are several power supply modules in the IQ SENSORNET, it is helpful if all the power supply modules are connected to a single power supply. As a result, the system can be easily switched on and off from a single location.

3.5 Electrical connections: General instructions

Cable glands

All electric cables are fed into the enclosure of the MIQ/Blue PS from below through prepared openings. Cable glands with different clamping ranges are provided with the MIQ/Blue PS to provide sealing between the cable and enclosure as well as for strain relief. Select the suitable cable gland for the respective cable diameter:

- **Small**, clamping range 4.5 to 10 mm. This cable gland is suitable for all IQ SENSOR NET cables.

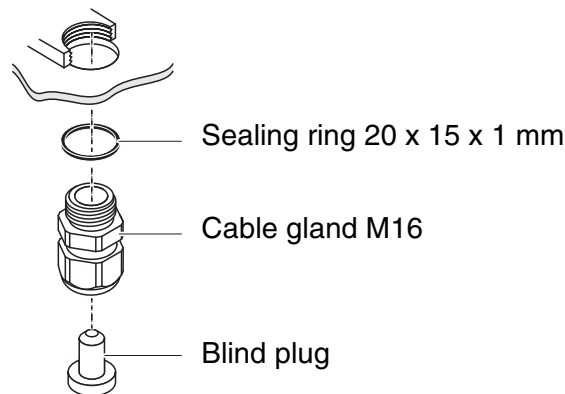

- **Large**, clamping range 7 to 13 mm. This cable gland is required for cable sheaths with an outer diameter of more than 10 mm and is screwed into the enclosure via an extension piece.

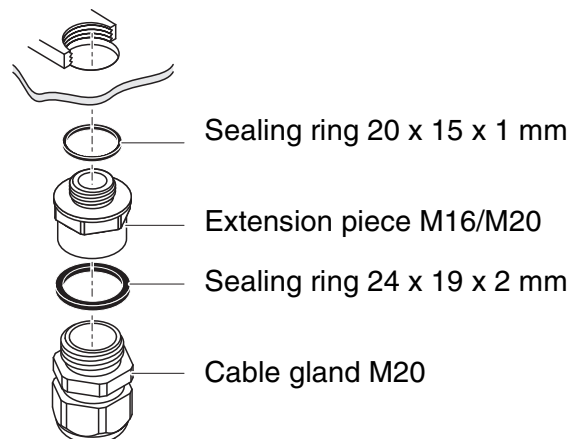

Note

If necessary, you can order additional large cable glands as a set of 4 pieces (model EW/1, order number 480 051).

General installation instructions

Observe the following points when attaching connecting wires to the terminal strip:

- Shorten all the wires to be used to the length required for the installation
- Always fit all the ends of the wires with wire end sleeves before connecting them to the terminal strip
- Any wires that are not used and project into the enclosure must be cut off as closely as possible to the cable gland.
- In each of the remaining free openings, screw in a small cable gland with sealing ring and close them with a blind plug.

**Warning**

No free wires must be allowed to project into the enclosure. Otherwise, there is a danger that areas safe to contact could come into contact with dangerous voltages. This could result in life threatening electric shock when working with the IQ SENSORNET. Always cut off any wires that are not in use as closely as possible to the cable gland.

3.6 Connecting the voltage supply

The following two sections need only be observed if the IQ SENSORNET island should be supplied with power by the MIQ/Blue PS.

3.6.1 Connection to 100 ... 240 V AC



Warning

If the power supply is connected incorrectly, it may represent a danger to life from electric shock. Pay attention to the following points during installation:

- The MIQ/Blue PS may only be connected by a trained electrician.
- The connection of the MIQ/Blue PS to the power supply may only be carried out when it is not carrying any voltage.
- The power supply must fulfill the specifications given on the nameplate and in chapter 6 TECHNICAL DATA.
- When installed in a building, a switch or power switch must be provided as an interrupt facility for the MIQ/Blue PS. The interrupt facility must
 - be installed in the vicinity of the MIQ/Blue PS, easily accessible by the user, and
 - be labeled as an interrupt facility for the MIQ/Blue PS.
- After it has been installed, the MIQ/Blue PS may only be opened if the mains voltage has been switched off beforehand.

Materials required

- Wire end sleeves, suitable for the power line, with suitable crimping tool
- 1 x cable gland, suitable for the cable diameter (see section 3.5 on page 3-14).

Tools

- Cable stripping knife
- Wire stripper
- Phillips screw driver
- Small screw driver.

Preparing the power cable

1	Cut off the cable to the required length.
2	Strip the cable insulation for approx. 45 mm.
3	Bare the wires of phases L and N and fit them with wire end sleeves.
4	If present, cut off the protective ground wire at the end of the cable sheath.

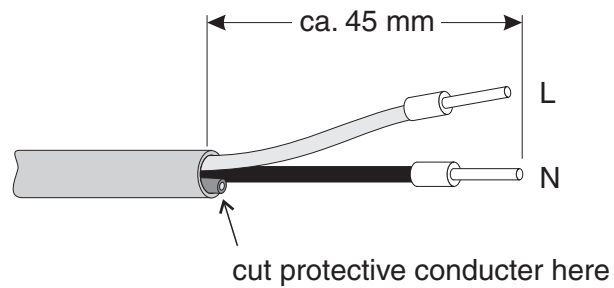

Fig. 3-11 Prepared power cable.

**Caution**

The ground wire must not project into the enclosure. Otherwise, malfunctions could occur.

Connecting the power line

- 5 | Open the enclosure.

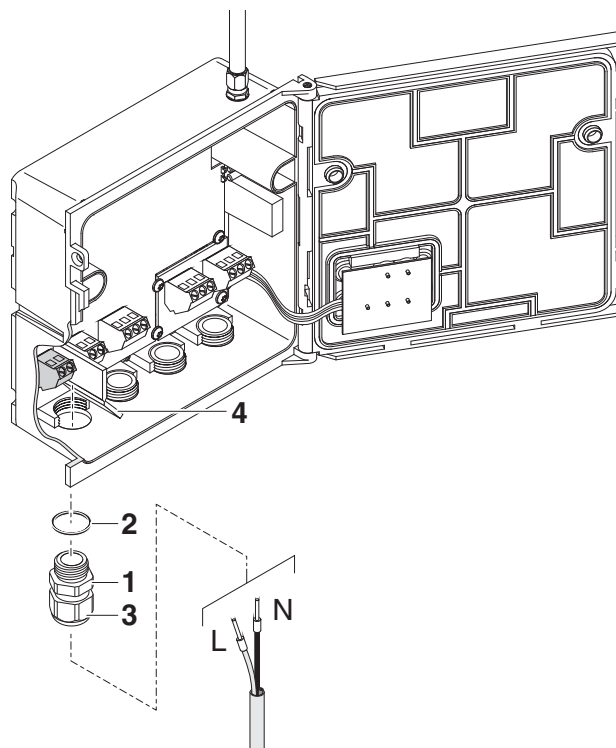

Fig. 3-12 Inserting the supply line.

- 6 | Screw a cable gland (pos. 1 in Fig. 3-12) with sealing ring (pos. 2) into the enclosure below the power supply connection.
- 7 | Loosen the coupling ring (pos. 3).
- 8 | Feed the power line through the cable gland into the enclosure. When doing so bend the flexible divider (pos. 4) to the right.

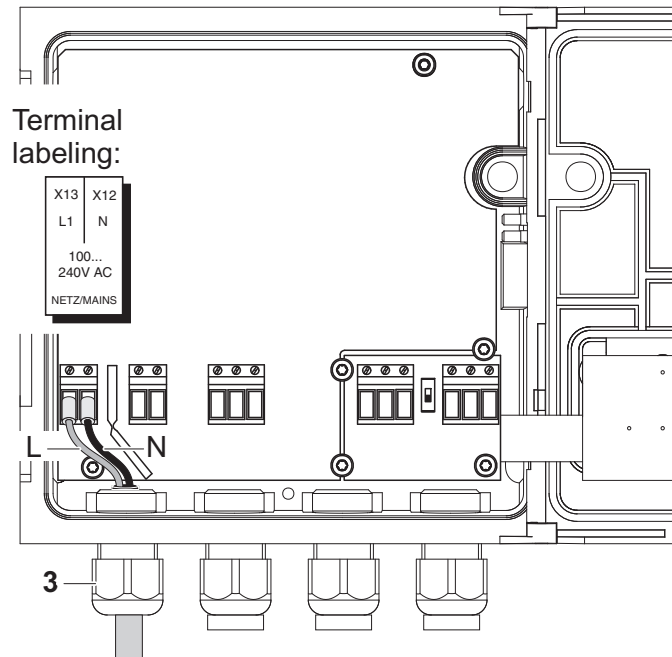

Fig. 3-13 Line power connection.



Note

The complete assignment of the terminal strip is shown in section 3.7.

- | | |
|----|---|
| 9 | Connect phases L and N to the terminal strip. Make sure that the cable assignment agrees with the specification on the terminal label under the terminal strip. |
| 10 | Tighten the coupling ring (pos. 3). |



Warning

No free wires must be allowed to project into the enclosure. Otherwise, there is a danger that areas safe to contact could come into contact with dangerous voltages. Always cut off any wires that are not in use as closely as possible to the cable gland.

- | | |
|----|----------------------|
| 11 | Close the enclosure. |
|----|----------------------|

3.6.2 Connection to 24 V DC



Warning

If the 24 V DC supply is connected incorrectly, it may represent a danger to life from electric shock. Pay attention to the following points during installation:

- The MIQ/Blue PS may only be connected by a trained electrician.
- The 24 V DC supply must meet the specifications quoted on the nameplate and in chapter 6 TECHNICAL DATA (protective low voltage SELV).
- The connection of the MIQ/Blue PS to the power supply may only be carried out when it is not carrying any voltage.
- When installed in a building, a switch or power switch must be provided as an interrupt facility for the MIQ/Blue PS. The interrupt facility must
 - be installed in the vicinity of the MIQ/Blue PS, easily accessible by the user, and
 - be labeled as an interrupt facility for the MIQ/Blue PS.



Note

Battery systems should be protected against total discharge. The MIQ/Blue PS has no integrated deep discharge protection.

Materials required

- Wire end sleeves, suitable for the 24 V AC/DC feed line, with suitable crimping tool
- 1 x cable gland, suitable for the cable diameter (see section 3.5 on page 3-14).

Tools

- Cable stripping knife
- Wire stripper
- Phillips screw driver
- Small screw driver.

Preparing the 24 V DC line

1	Cut off the cable to the required length.
2	Strip the cable insulation for approx. 45 mm.
3	Bare the wires 1 and 2 and fit them with wire end sleeves.

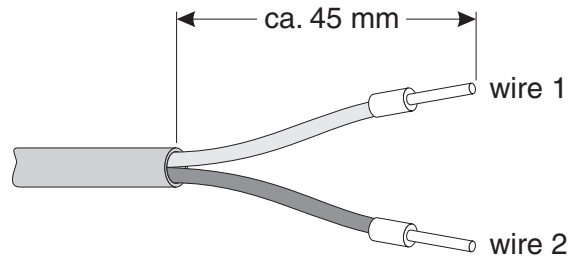

Fig. 3-14 Prepared 24 V DC line.

Connecting the 24 V DC line

- 4 | Open the enclosure.

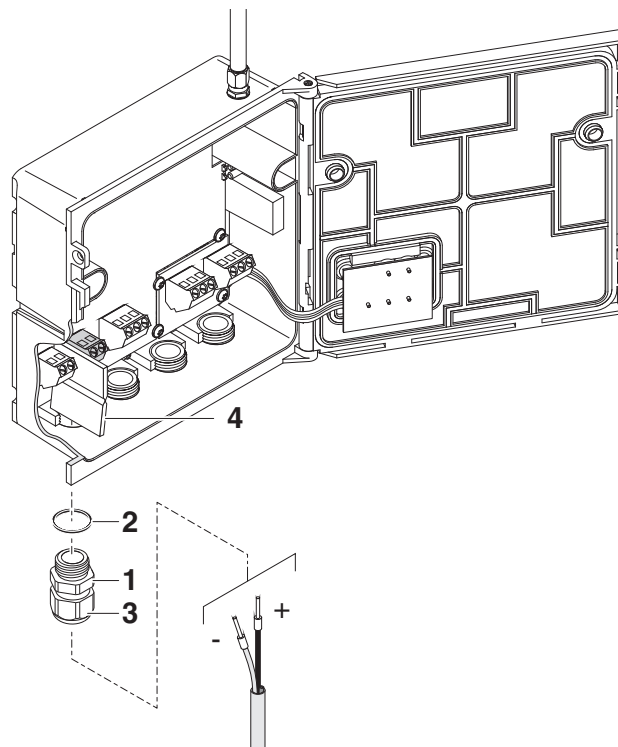

Fig. 3-15 Inserting the 24 V DC line.

- 5 | Screw a cable gland (pos. 1 in Fig. 3-15) with sealing ring (pos. 2) into the enclosure below the 24 V DC connection.
- 6 | Loosen the coupling ring (pos. 3).
- 7 | Feed the 24 V DC line through the cable gland into the enclosure. When doing so bend the flexible divider (pos. 4) to the left.

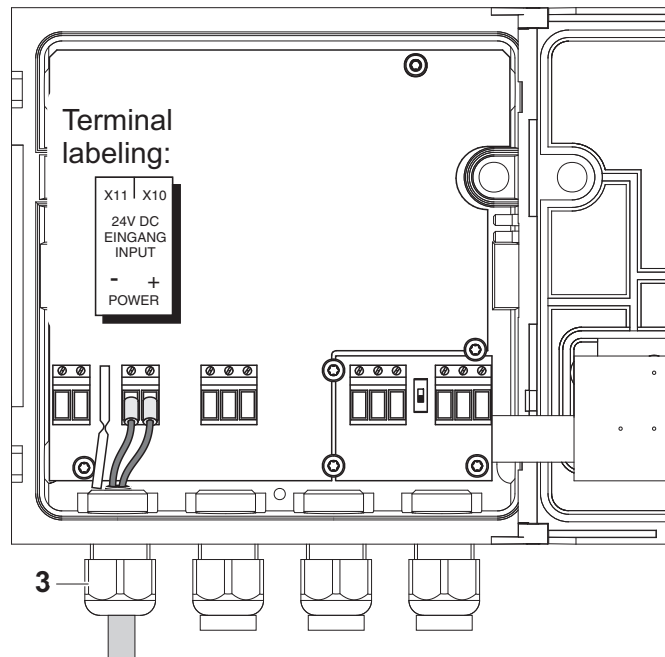
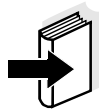

Fig. 3-16 Line power connection.



Note

The complete assignment of the terminal strip is shown in section 3.7.

- | | |
|---|--|
| 8 | Connect wires 1 and 2 to the terminal strip. Make sure that the cable assignment agrees with the specification on the terminal label under the terminal strip. |
| 9 | Tighten the coupling ring (pos. 3). |



Warning

No free wires must be allowed to project into the enclosure. Otherwise there is the danger of short circuits that can cause a fire. Always cut off any wires that are not in use as closely as possible to the cable gland.

- | | |
|----|----------------------|
| 10 | Close the enclosure. |
|----|----------------------|

3.7 Figure of the terminal strip

X13	X12		X11	X10		X9	X8	X7		X6	X5	X4	SN TERMINATOR		X3	X2	X1
L1	N		24V DC			RED	SHIELD	GREEN		RED	SHIELD	GREEN	ON	OFF	RED	SHIELD	GREEN
100... 240V AC			INPUT														
NETZ/MAINS			- +			SENSORNET 3				SENSORNET 2			SENSORNET 1				

Fig. 3-17 MIQ/Blue PS terminal strip

4 Maintenance and cleaning

4.1 Maintenance

The MIQ/Blue PS requires no special maintenance. The general maintenance of IQ SENSORNET components is described in the IQ SENSORNET system operating manual.

4.2 Cleaning

The cleaning of IQ SENSORNET components is described in the IQ SENSORNET system operating manual.

5 What to do if ...

5.1 Check of the radio connection

A yellow LED inside of both MIQ/Blue PS modules indicates the status of the radio connection:

LED state	Connection status
Permanently on	Connection OK, no data transmission activity
Flickering	Connection OK, data transmission active
Permanently off	No connection

The status LED is located at the top edge of the rear radio board:

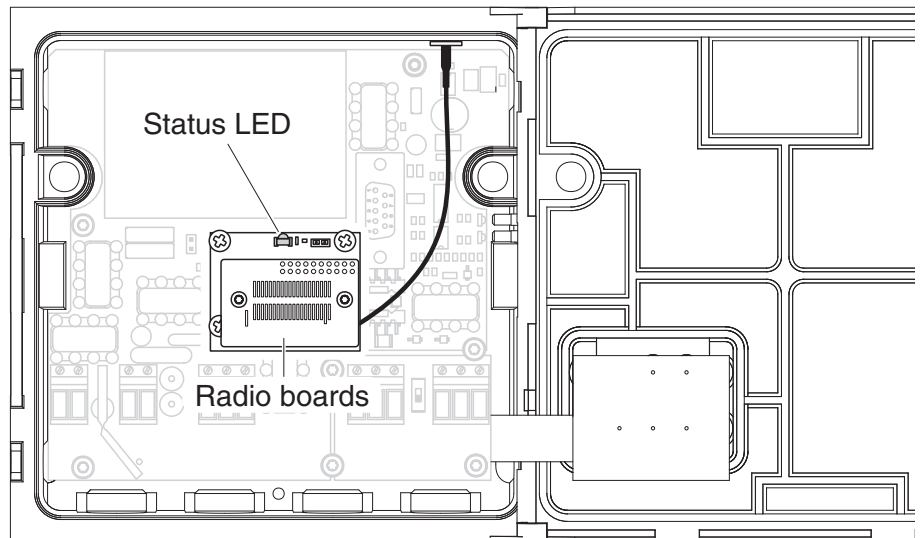

Fig. 5-1 Status LED radio connection

5.2 Error causes and remedies

Already established radio connection does no longer work

Cause	Remedy
– Obstacle in the radio link	– Remove the obstacle
– Range at the limit	– see following point, RANGE INSUFFICIENT
– Moisture on antenna surface	– Wipe the antenna dry – Use a canopy
– The radio link is not active despite the display on the radio PCB (status LED permanently on)	– Switch on and after 5 seconds off again both MIQ/Blue PS modules

Range insufficient

Cause	Remedy
– Obstacle in the radio link	– Remove the obstacle – Mount the MIQ/Blue PS in a higher position (e.g. on a pole) – Make sure there is "visual contact" between the MIQ/Blue PS modules
– MIQ/Blue PS too close to the ground	– Mount the MIQ/Blue PS in a higher position (e.g. on a pole)
– Shielding by metal canopy	– Use plastic canopy SSH/IQ

6 Technical data



Note

General technical data on MIQ modules are given in the TECHNICAL DATA chapter of the IQ SENSORNET system operating manual.

6.1 Electrical data

6.1.1 Operation without line power supply unit

Nominal voltage	Max. 24 V DC via the IQ SENSORNET (for details, see chapter TECHNICAL DATA of the IQ SENSORNET system operating manual).
Power consumption	0.6 W

6.1.2 Operation with line power supply unit

**100 ... 240 V AC
operation**

Supply	<p>Nominal voltage: 100 ... 240 V AC \pm 10 %</p> <p>Frequency: 50/60 Hz according to DIN IEC 60038</p> <p>Line power connection: 2 pin, N and L</p> <p>Line cross-section of mains connection: Europe: 1.5 ... 4.0 mm² USA: AWG 14 ... 12</p> <p>Fuse rating on the operator side: max. 16 A</p>
Power consumption	Approx. 12 W
Output voltage	Max. 24 VDC via the IQ SENSORNET (for details, see chapter TECHNICAL DATA of the IQ SENSORNET system operating manual).

Power output

Up to 47 °C (117 °F) ambient temperature 7 W; over 47 °C (117 °F) the power delivery is reduced linearly to 4.4 W at 55 °C (131 °F):

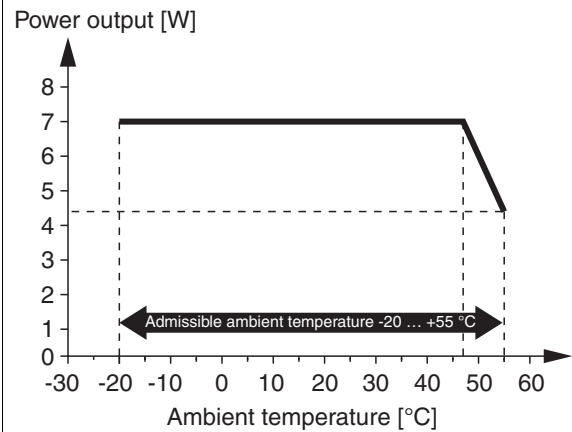

Protective class

II

Overvoltage category

II

24 V DC operation

Supply

Input: 23 ... 26.5 V DC / max. 1 A
 protective low voltage SELV (Safety Extra Low Voltage)

Ripple: < 5 %

Connection: 2 pin

Line cross-section of connections:
 Europe: 1.5 ... 4.0 mm²
 USA: AWG 14 ... 12

Fuse rating on the operator side: max. 16 A

Power consumption

Max. 24 W

Output voltage

Max. 24 VDC via the IQ SENSORNET (for details, see chapter TECHNICAL DATA of the IQ SENSORNET system operating manual).

Power output

Max. 24 W

6.1.3 Electrical connections

Terminal strip inside the enclosure

X13	X12		X11	X10		X9	X8	X7		X6	X5	X4	ON	S/NTERMINATOR	X3	X2	X1
L1	N		24V DC EINGANG INPUT			RED ROT	SHIELD SCHIRM	GRÜN GRÜN		RED ROT	SHIELD SCHIRM	GRÜN GRÜN	△	OFF AUS	RED ROT	SHIELD SCHIRM	GRÜN GRÜN
100... 240V AC NETZ/MAINS			- + POWER		SENSORNET 3			SENSORNET 2			SENSORNET 1						

Terminals

Terminal type	Screw-type terminal strip, accessible by opening the lid	
Terminal ranges	Solid wires:	0.2 ... 4.0 mm ² AWG 24 ... 12
	Flexible wires:	0.2 ... 2.5 mm ²

Cable glands

Suitable for cable diameter	4.5 ... 10 mm or 7 ... 13 mm
-----------------------------	------------------------------

6.2 Radio transmission

Radio frequency	2.402 ... 2.480 GHz
Transmitting power	max. 20 dBm or 100 mW
Bridgeable distance	max. 100 m (328 ft) The specified maximum range applies if the radio link was installed and tested according to this operating manual (see section 3.3).

6.3 Instrument safety

Used directives and standards

In addition to the standards listed in the IQ SENSORNET system operating manual, the MIQ/Blue PS is based on the following directives and standards:

Data radio	<ul style="list-style-type: none"> – EEC directive 1999/5/EC (R&TTE directive) – EN 300 328-2
------------	---

7 Appendix: Installation instructions for several radio links

7.1 General information

If no further 2,4 GHz radio links ("Pico nets", e. g. Bluetooth or WLAN devices) of other manufacturers operate in the same radio area, 10 MIQ/Blue PS SETs can be operated at a plant at the same time.

The appendix describes the special features that have to be taken into account when several radio links should be established in an IQ SENSORNET system.

7.2 Application example for several radio links

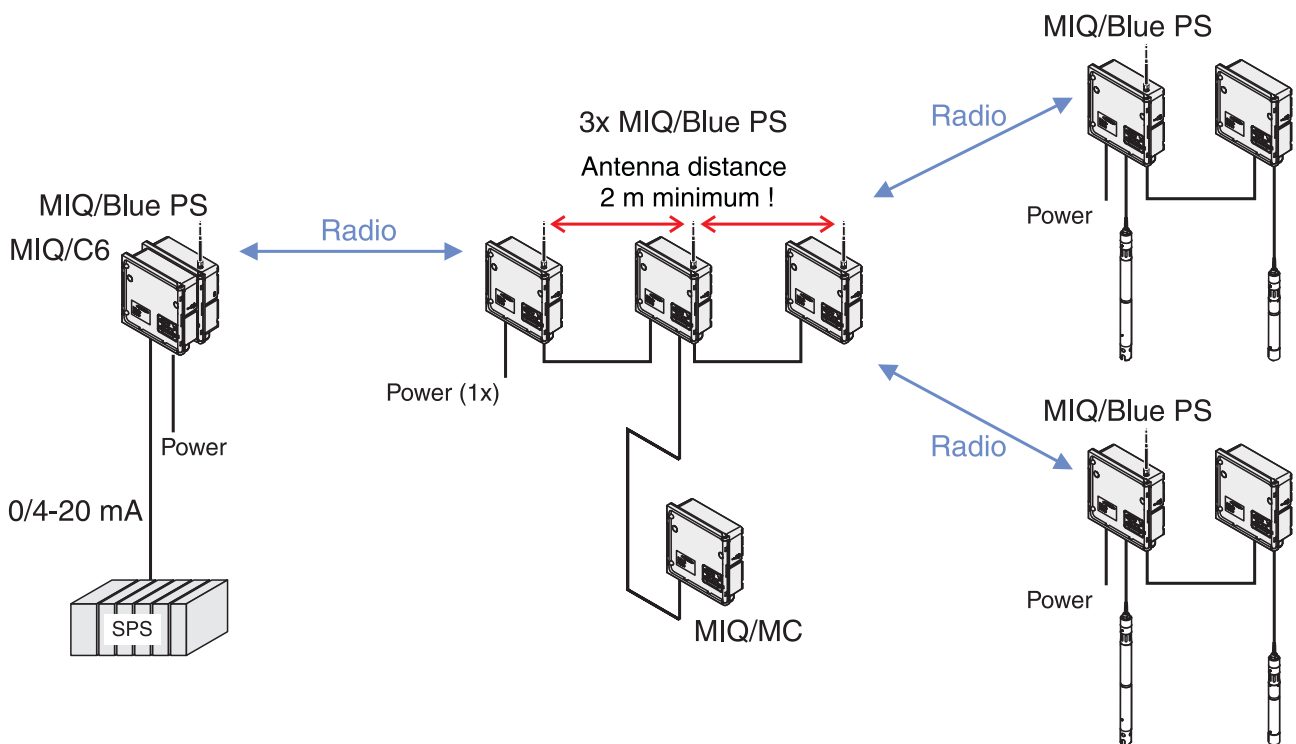

Fig. 7-1 Example 3: Star-shaped structure - controller in the center

7.3 Power supply

Several MIQ/Blue PS modules on an IQ SENSORNET island

If several MIQ/Blue PS modules are positioned on one IQ SENSORNET island, only one of them can take over the power supply. All other MIQ/Blue PS modules count as consumers in the power rating (power requirement 0.6 W). Accordingly, only one MIQ/Blue PS module has to be connected to the power supply.

Compatibility with other line power supply units

If other power supply modules (e.g. MIQ/PS) are installed on the IQ SENSORNET island, the line power supply units of all MIQ/Blue PS modules are automatically inactive. Connecting the MIQ/Blue PS line power supply units to a power supply remains ineffective here. In this case, all MIQ/Blue PS modules are consumers with a power consumption of 0.6 W each in the power rating.

Example

Problem:

- An IQ SENSORNET island should consist of the following components plus two MIQ/Blue PS modules:

Component	Power requirement [W]
VisoTurb® 700 IQ	1.5
ViSolid® 700 IQ	1.5
SensoLyt® 700 IQ	0.2
MIQ/CHV PLUS	1.0
MIQ/TC 2020 XT (docked from time to time)	3.0

- In this example, both MIQ/Blue PS modules and the MIQ/CHV PLUS should be mounted as a stack.
- The IQ SENSORNET system should be supplied with 100 ... 240 V AC.

Solution/proceeding:

- An MIQ/Blue PS module counts as a consumer with 0.6 W. In the worst case, i. e. with a docked MIQ/TC 2020 XT, the power requirement of all components is 7.8 W. Power losses in cables do not have to be taken into account due to the stack mounting.
- Power rating: The calculated power requirement is greater than the maximum power delivery of the MIQ/Blue PS line power supply unit. Therefore, an additional power supply module has to be installed (e.g. MIQ/PS).
- New power rating: The second MIQ/Blue PS module has to be taken into account as a consumer as well. Therefore, the power consumption is now 8.4 W. With an MIQ/PS power supply module (18 W), there is still an energy reserve of 9.6 W for any future extensions.

8 Contact Information

8.1 Ordering & Technical Support

Telephone: (800) 897-4151
(937) 767-7241
Monday through Friday, 8:00 AM to 5:00 PM ET

Fax: (937) 767-9353 (orders)
(937) 767-1058 (technical support)

Email: environmental@ysi.com

Mail: YSI Incorporated
1725 Brannum Lane
Yellow Springs, OH 45387
USA

Internet: www.ysi.com

When placing an order please have the following information available:

YSI account number (if available)	Name and Phone Number
Model number or brief description	Billing and shipping address
Quantity	Purchase Order or Credit Card

8.2 Service Information

YSI has authorized service centers throughout the United States and Internationally. For the nearest service center information, please visit www.ysi.com and click 'Support' or contact YSI Technical Support directly at 800-897-4151.

When returning a product for service, include the Product Return form with cleaning certification. The form must be completely filled out for an YSI Service Center to accept the instrument for service. The Product Return form may be downloaded at www.ysi.com and clicking on the 'Support' tab.

Xylem ['zīləm]

- 1) The tissue in plants that brings water upward from the roots;
- 2) a leading global water technology company.

We're 12,500 people unified in a common purpose: creating innovative solutions to meet our world's water needs. Developing new technologies that will improve the way water is used, conserved, and re-used in the future is central to our work. We move, treat, analyze, and return water to the environment, and we help people use water efficiently, in their homes, buildings, factories and farms. In more than 150 countries, we have strong, long-standing relationships with customers who know us for our powerful combination of leading product brands and applications expertise, backed by a legacy of innovation.

For more information on how Xylem can help you, go to www.xyleminc.com



a **xylem** brand

YSI
1725 Brannum Lane
Yellow Springs, OH 45387
Tel: +1 937-767-7241; 800-765-4974
Fax: +1 937-767-1058
Email: environmental@ysi.com
Web: www.ysi.com

©Xylem Inc